



BAA and TAA available. Contact factory for more information and pricing.

Project:	
Type:	
Catalog #:	



Hazardous Location/Explosion Proof LED

FME Sun-Series

Product Description

The SUN Series LED Luminaire can be used in locations made hazardous by the presence of flammable vapors, gases or combustible dusts or fibers as defined by NEC, ATEK, IECEx. The SUN Series can also be used in heavy duty environments where dust, water, vibration and corrosion exist. The housing is die-cast aluminum with a powder coat paint finish. Bolts and brackets are stainless steel. Pendant mount or side (feed through) is standard. **An adjustable U-Bracket comes standard.** The SUN Series can also be pendant or side (feed through) mounted. The lens is flat tempered glass or glass with polycarbonate lens for different beam angles. Emergency battery backup is available.



Features

- 2ft and 4ft lengths available
- Meanwell Driver
- High efficacy: up to 140lm/W
- CRI > 70
- Standard 120-277V, Available options include
 - 277-480V
 - 12-36VDC
- Temp Rating -40°C to +60°C (140°F) (20-80W models)
- Temp Rating -40°C to +40°C (104°F) (90-120W models)
- Three connection cable entry
- Aircraft Aluminum Housing with Marine Die-Cast Powder Coat Finish
- Adjustable
- Standard 10KV surge protection
- Standard integrated junction box
- 1.5-3 Hour Emergency Operation (Option)
- 5 or 10 Year Limited Warranty (specify in part number)

Compliance

UL 844 Hazardous Locations North America

- Class I, Division I, Group C,D
- Class I, Division II, Group A,B,C,D
- Class II, Division I & II, Group E,F,G
- Class III

Marking Atex

- II2 G Ex db op is IIB T4/T5 Gb
- II2 D Ex op is tb IIIC T135°C Db IP66

Marking ICEX

- Ex db op is IIB T4/T5 Gb
- Ex op is tb IIIC T135°C Db

Marking Marine

- UL1598, UL1598A
- ABS

Other Markings / Standards

- UL 1598 Wet Locations
- UL 8750 LED Safety
- DLC Listed
- CSA C22.2 No. 250.0-08
- CSA C22.2 No. 137-M1981

Applications

- Power Plants / Heavy Industrials
- Distillery, Alcohol
- Paper Mills / Wastewater Treatment Plants
- Loading Docks / Platforms / Shipyards
- Chemical Processing Facility
- Petrochemical Processing Facility
- Mining
- Ocean Marine
- LNG facilities
- Metal Industry

Light Distribution

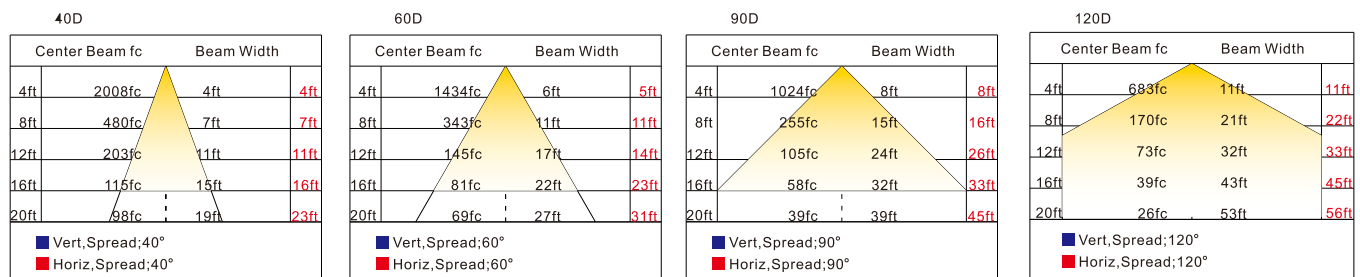

Product Dimensions

Hazardous Location LED Luminaire

2'

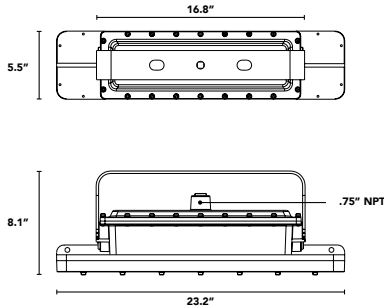

4'

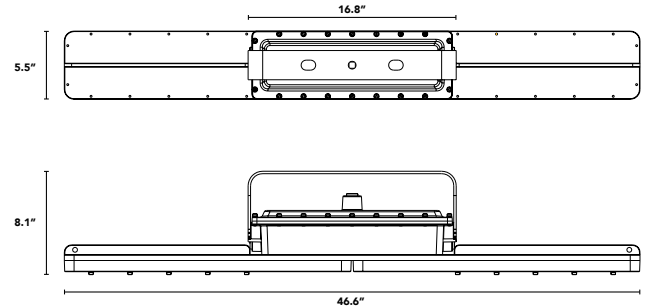

Note

**Housing dimensions change when Emergency function is selected in the ordering guide. Please contact FME Lighting for Emergency operation housing dimensions.

Lumen Chart

	3500K	4000K	5000K	5700K
20W	2,000 lm	2,560 lm	2,700 lm	2,800 lm
30W	3,600 lm	3,840 lm	4,050 lm	4,200 lm
40W	4,800 lm	5,120 lm	5,400 lm	5,600 lm
50W	6,000 lm	6,400 lm	6,750 lm	7,000 lm
60W	7,200 lm	7,680 lm	8,100 lm	8,400 lm
80W	9,600 lm	10,240 lm	10,800 lm	11,200 lm
100W	12,000 lm	12,800 lm	13,500 lm	14,000 lm
120W	14,400 lm	15,360 lm	16,200 lm	16,800 lm

Ordering Guide

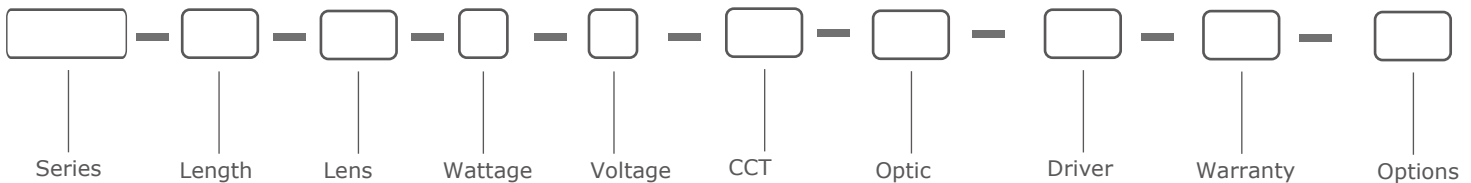

<u>SERIES</u>	<u>LENGTH</u>	<u>LENS</u>	<u>WATTAGE</u>	<u>VOLTAGE</u>	<u>COLOR TEMP</u>	<u>OPTIC</u>	<u>DRIVER</u>	<u>WARRANTY</u>
FME-SUN	2 ¹ = 2' 4 = 4'	G= Glass Flat	2 = 20W 3 = 30W 4 = 40W 5 = 50W 6 = 60W 8 = 80W 10 = 100W 12 = 120W	A=AC 100-277V B=AC 277-480V C=DC 12-36V	S2= 3000K I = 4000K C = 5000K K = 6000K	R = 120°	D = Dimmable ND = Non-Dimmable	5Y = Five Year Std 10Y* = Ten Year Warranty*

*Please contact factory for 10yr option.

OPTION

EM³ = 90 Minute Emergency Operation

CL = Cable Length (Specify Length)

OPEB = Junction Box

BAA** = Buy American Act Compliant**

TAA** = Trade Agreements Act Compliant**

**Please contact factory for BAA and TAA options.

Notes

- 2' Version available in 20W / 30W / 40W / 50W / 60W.
- Contact factory for customer color temperatures (<3000K / >6000K).
- Operating Temperature Emergency Function:
 - 40C to +55C (131°F) (20-80W models)
 - 40C to +40C (104°F) (90-120W models)



Sun Series Specification

Chain Mounting



⚠ WARNING
Risk of fire, Electric shock or personal injury
Please turn off power before installation!

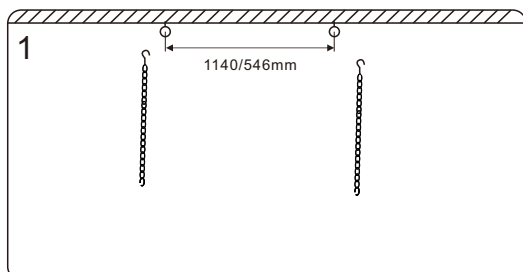

1. Drill 2x hole for hanging ring(1140mm for 4FT fixture or 546mm for 2FT fixture), and fixing them.

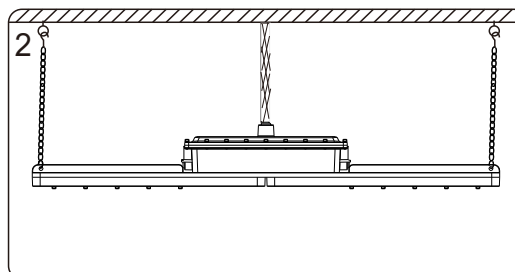

2. Fix the hanging chain to light fixture. Wire the cable through the metal conduit and then connect it with the power.

Pole Mounting

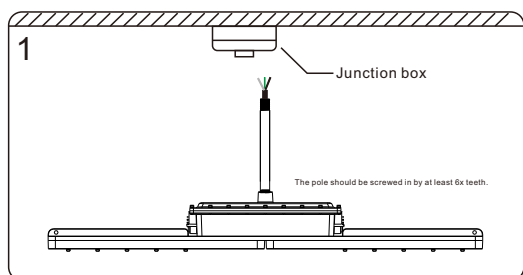

1. Wire the cable through the pole and then install the pole to the fixture.

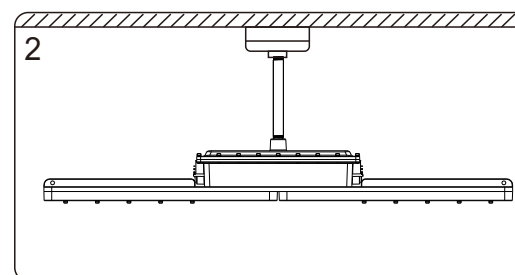

2. Wire the cable to enclosure of junction box and install the pole to junction box.

Bracket Mounting

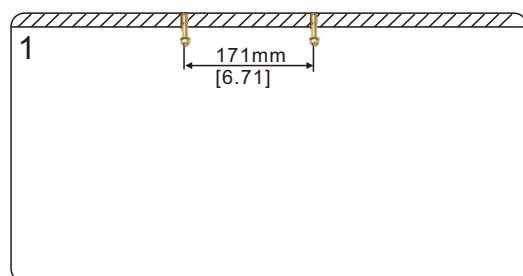

1. Drill 2x $\varnothing 15$ holes for expanded screws, and fix them to the ceiling.

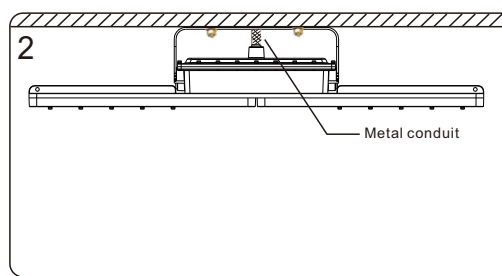

2. Install the fixture to the expanded screws, and tighten the nuts. (Metal conduit need to apply here)

Pole Bracket Mounting

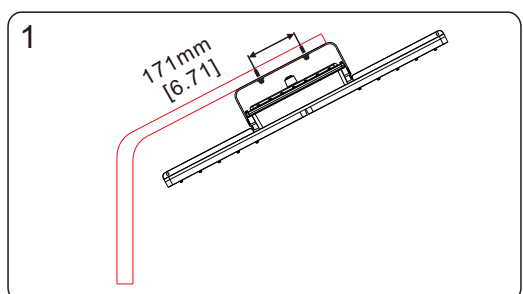

1. Drill 2x $\varnothing 15$ holes for fixing screws.

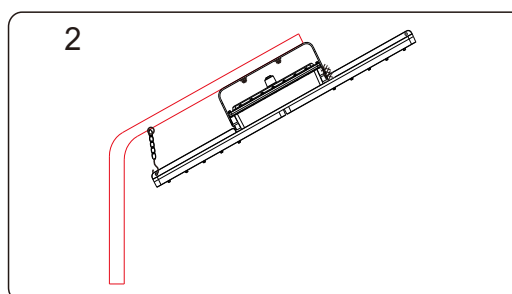

2. Fix the pendant chain and hook the fixture. Insert 2x $\varnothing 15$ fixing screws and weld them on the pole bracket with the fixture.

Sun Series Specification

Wall Mounting



1. Drill 2x Ø15 hole for expanded screws, and fix them to the wall. (Horizontal distance: 171mm)

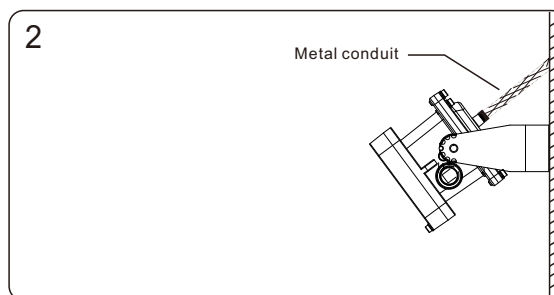

2. Install the fixture to wall and connect the wire to AC power. (Metal conduit needs to apply here)

Packing Information

Model	Quantity/Ctn	Length (in)	Width (in)	Height (in)	Fixture weight (lbs)	Gross weight (lbs)
2'	1	30	13	10	28	32
4'	1	53	13	10	41	47

Accessories



- Model: X-J1
- Name: Junction Box
- Material: Cast Aluminum



- Model: X-CHAIN
- Name: Pendant Chain
- Material: Stainless Steel S30400

Installation Manual

READ INSTRUCTIONS CAREFULLY BEFORE INSTALLING. KEEP THIS INSTRUCTIONS FOR FUTURE REFERENCE. Fixtures must be wired in accordance with the National electrical code and all applicable local codes. Proper grounding is required for safety. THIS PRODUCT MUST BE INSTALLED IN ACCORDANCE WITH THE APPLICABLE INSTALLATION CODE BY QUALIFIED ELECTRICIAN WHO IS FAMILIAR WITH THE CONSTRUCTION AND OPERATION OF THE PRODUCT AND THE HAZARDOUS INVOLVED.

- Warning:** Risk of fire or electric shock. Linear light installation requires knowledge of luminaires and electrical systems. DO NOT open the enclosure when energized. DO NOT try to install if not qualified. Please contact a professional electrician.
- Warning:** Risk of fire or electric shock. Suitable for wet locations. Make sure the power is off prior to installation.
- Warning:** Risk of fire or electric shock. Suitable for non-insulated surface and frame. DO NOT cover fixture with insulation liner or similar material.
- Warning:** DO NOT install in unstable, loose or breakable surfaces.
- Warning:** DO NOT let objects impact or exert force on the surface of the fixture.