

Project:	
Type:	
Catalog # :	

FME Lighting | 877 - 234 - 8460 | info@fmelighting.com

DIMENSIONS

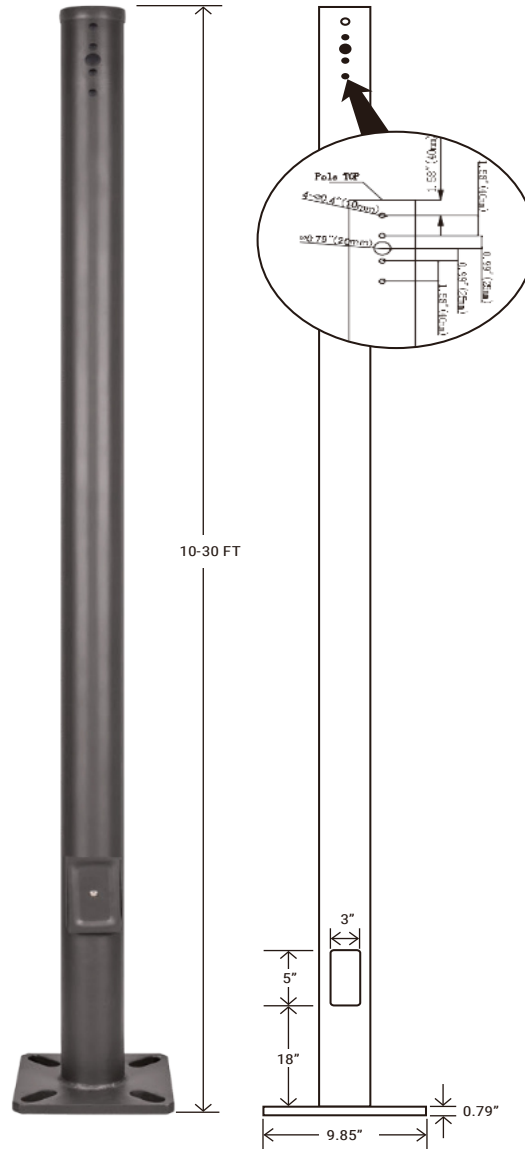

KEY FEATURES

- Constructed from high-strength aluminum for durability
- Versatile design with options for side drilling or tenon mounts
- Suitable for various lighting types, including arm-mounted, flood, and post-top luminaries
- Ideal for a range of applications: retail centers, industrial parks, educational institutions, public transportation hubs, and medical facilities
- Adjustable mounting heights ranging from 10 to 30 feet to accommodate different luminary applications

SPECIFICATIONS

Accessories need to purchased separately

Pole Shaft

The pole shaft is extruded from seamless 6061-T6 aluminum. Conforms to ASTM F1554 Grade 55.

Finish

Textured Architectural Bronze Powdercoat Finish, Baked to Ensure Maximum Paint Adhesion, Hardness and Durability

Anchor Bolts

Sized Based on Pole Data Charts for the Selected Pole Size. Anchor Bolts are not Included

Base Cover

Poles are Provided With a Two-Piece Formed aluminum Base Cover that is Easily Assembled and Fitted Over Pole Base.

Pole Length

Poles are Available in Standard Lengths as Shown in the Order Matrix. Poles can be Custom Cut to Order. Consult Factory.

Mounting Options

Standard Length Poles Include 2 3/4" OD Tenon, Side Drilled 2@180 Degrees, Polycarbonate Top Cover and Hole Plugs for Unused Drilling Locations.

- Cut To Order Poles can be Side Drilled for 2@180 Degrees , Includes Polycarbonate Top Cover and Hole Plugs for Unused Drilling Locations.
- Cut To Order Poles May Also Be Ordered With 2 3/4" OD Tenons for Use With Post

Top Decorative Luminaries, Flood/Area Slip Fitter Fixtures, or Any of a Wide Variety of Pole Top Mounting Accessories.

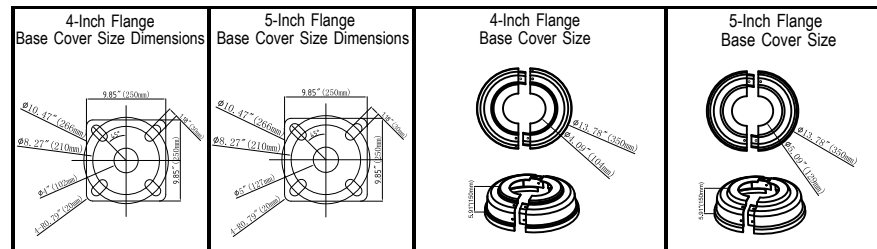

ORDERING INFORMATION

ORDERING GUIDE

Series	Height	Size	Wall Thickness	Mounting	Finish
SRP	1 = 10FT (3.0M) 2 = 15FT (4.6M) 3 = 20FT (6.1M) 4 = 25FT (7.6M) 5 = 30FT (9.1M)	A = 4in B = 5in C = 6in	S = 0.125inch L = 0.255inch	M = 2.5 inch adapter	C = Dark Bronze

Dimension data:

Catalog #	Mt. height	Wall thickness	Shaft size	Bolt size	Pole weight	EPA 80	EPA 90	EPA 100	EPA 110	EPA 120
SRP-1-A-S-M-C	10 ft.	0.125 in.	4x4 in.	M0.75"X19.69"X3.94"	35 lbs.	14.5	12.3	9.9	8.3	7.8
SRP-2-A-S-M-C	15 ft.	0.125 in.	4x4 in.		37 lbs.	8.3	6.1	5.4	4.8	3.9
SRP-3-A-S-M-C	20 ft.	0.125 in.	4x4 in.		72 lbs.	4.2	3.6	2.5	1.9	1.3
SRP-4-A-L-M-C	25 ft.	0.255 in.	5x5 in.		136 lbs.	9.3	7.2	6.2	5.2	4.6
SRP-5-B-L-M-C	30 ft.	0.255 in.	6x6 in.	M0.75"X36"X4"	189 lbs.	11.1	8.0	6.7	4.7	3.4

Specification type	10FT	15FT	20FT	25FT	30FT
SRP-1-A-S-M-C	Length=3.0 (m)	Length= 4.6 (m)	Length= 6.1 (m)	Length= 7.6 (m)	Length=9.1 (m)
SRP-2-A-S-M-C					
SRP-3-A-S-M-C					
SRP-4-A-L-M-C					
SRP-5-B-L-M-C					

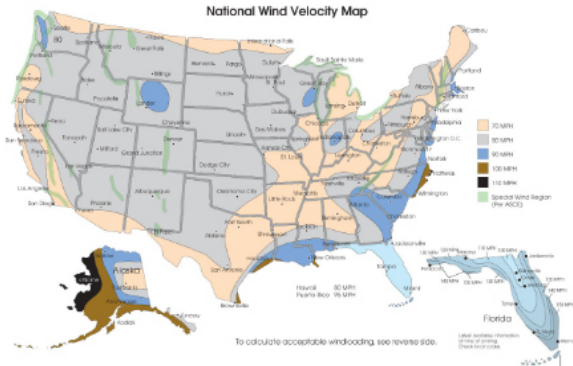

Light pole top:

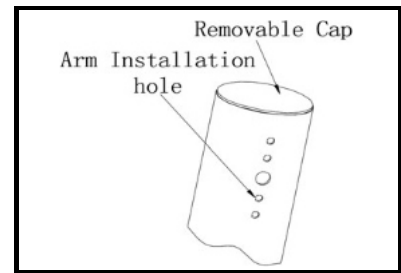

Installation:

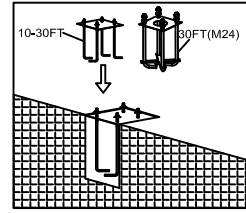

10-30FT (M24)

1. Dig a hole in the installation position of the lamp pole. Fixed four fastener fittings according to the hole position of lamp pole and poured with cement concrete. (as shown in the figure)

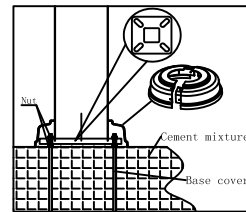

2. Install 4 screws onto the stick and adjust to same water level, then place the square plate and screw tightly. Install the cover at the bottom of pole. (as shown in the figure)

Foundation reference specification

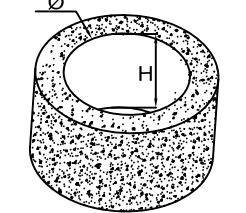

ANCHORAGE GUIDE

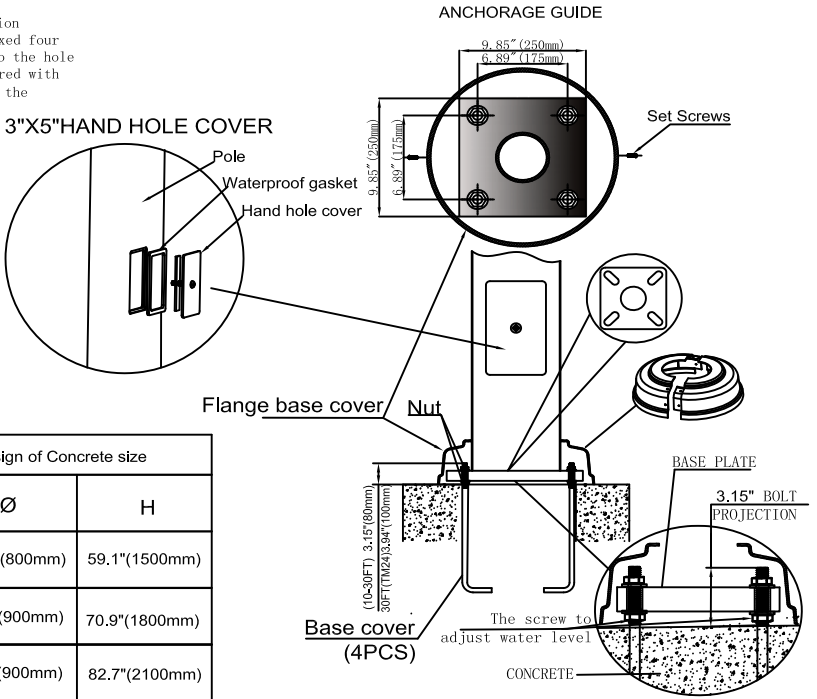

3"X5" HAND HOLE COVER

Pole

Waterproof gasket

Hand hole cover

Flange base cover

Nut

Set Screws

BASE PLATE

3.15" BOLT PROJECTION

Base cover (4PCS)

The screw to adjust water level

CONCRETE

9.85" (250mm)

6.89" (175mm)

6.89" (175mm)

9.85" (250mm)

(10-30FT) 3.15"(80mm)

30FT(M24)3.94"(100mm)

Reference design of Concrete size

Specifications	Ø	H
10-15FT	31.5"(800mm)	59.1"(1500mm)
20-25FT	35.4"(900mm)	70.9"(1800mm)
30FT	35.4"(900mm)	82.7"(2100mm)

Foundation Design:We offer Foundation design references due to variations in soil structure across different areas, and we do not assume any responsibility for this variability.

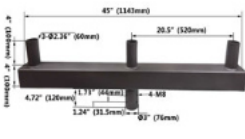
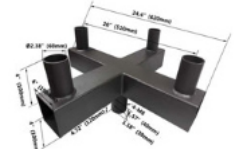
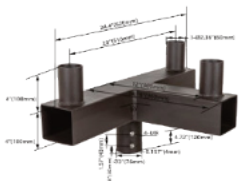
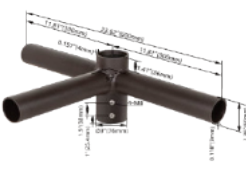
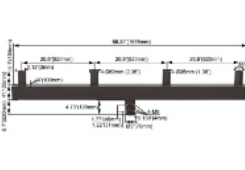

SQUARE EXTERNAL MOUNT HORIZONTAL TENON · To mount 2/3/4 fixtures on an existing pole

	<p>Low Profile Bullhorn with 3 Tenons LPB3 MAX EPA: 1.6 Finish: Dark Bronze USE: The Bracket is designed to mount over 2-3/8" O.D. vertical tenon. Two fixtures can be mounted to the Round External Mount Horizontal Tenon and adjusted horizontally.</p>		<p>Low Profile Bullhorn with 2 Tenons LPB2 MAX EPA: 1.0 Finish: Dark Bronze USE: The Bracket is designed to mount over 2-3/8" O.D. vertical tenon. Two fixtures can be mounted to the Round External Mount Horizontal Tenon and adjusted horizontally.</p>
	<p>Triple 120° Horizontal Tenon Adaptor T120TA MAX EPA: 1.4 Finish: Dark Bronze USE: The Bracket is designed to mount over 2-3/8" O.D. vertical tenon. Two fixtures can be mounted to the Round External Mount Horizontal Tenon and adjusted horizontally.</p>		<p>Quad 90° Horizontal Tenon Adaptor RQ90TA MAX EPA: 1.8 Finish: Dark Bronze USE: The Bracket is designed to mount over 2-3/8" O.D. vertical tenon. Two fixtures can be mounted to the Round External Mount Horizontal Tenon and adjusted horizontally.</p>
	<p>Square Triple 90° Horizontal Tenon Adaptor ST90TA MAX EPA: 1.5 Finish: Dark Bronze The Bracket is designed to mount over 2-3/8" O.D. vertical tenon.</p>		<p>Round Triple 90° Horizontal Tenon Adaptor RT90TA MAX EPA: 0.3 Finish: Dark Bronze The Bracket is designed to mount over 2-3/8" (60mm) O.D. vertical tenon. Triple fixtures can be mounted to the Round External Mount Horizontal Tenon and adjusted horizontally.</p>
	<p>Low Profile Bullhorn with 4 Tenons LPB4 MAX EPA: 1.7 Finish: Dark Bronze The Bracket is designed to mount over 2-3/8" O.D. vertical tenon.</p>		<p>Four 180° Horizontal Tenon Adaptor F180TA MAX EPA: 1.4 Finish: Dark Bronze The Bracket is designed to mount over 2-3/8" (60mm) O.D. vertical tenon. Four fixtures can be mounted to the Round External Mount Horizontal Tenon and adjusted horizontally.</p>





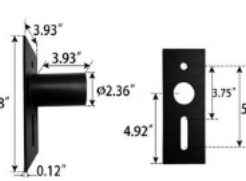
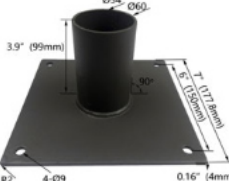
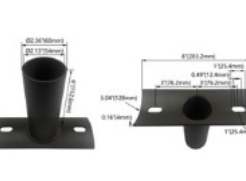

WALL BRACKET

- Attaches to any flat surface
- Provides wiring access

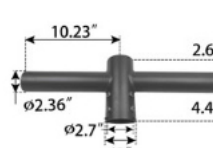
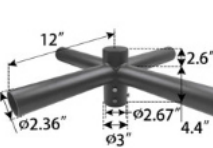
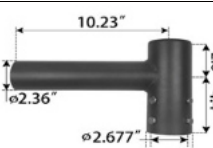
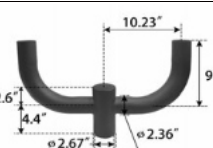
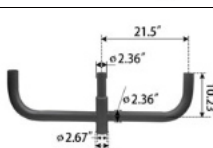

MID-POLE TENON BRACKET

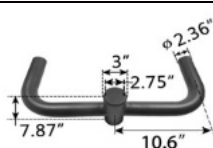
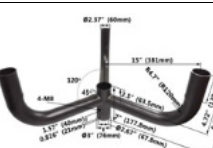

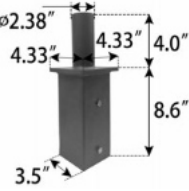
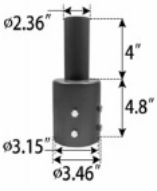
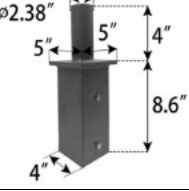
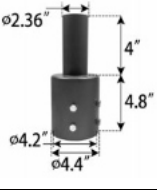

	<p>90° Wall Mount Bracket with 2-3/8" O.D. Tenon WM90T Finish: Dark Bronze MAX EPA: 0.6 USE: The 90° wall mount bracket with 2-3/8" tenon attaches flood and area fixtures to almost any surface: wall, roof, or wood pole. Provides wiring access and a built-in 2-3/8" O.D. tenon to mount a fixture with our adjustable slip-fitter. Suggested 3/8" diameter bolts for mounting. Mounting holes are spaced 3-1/4" apart.</p>		<p>2-3/8" OD Horizontal Tenon Mid-Pole Bracket MPBT Finish: Dark Bronze MAX EPA: 0.3 USE: 2-3/8" OD Horizontal Tenon Mid-Pole Bracket is designed to mount light fixture that is equipped with an adjustable slip-fitter onto a 2-3/8" OD horizontal tenon.</p>
	<p>180° Wall Mount Bracket with 2-3/8" O.D. Tenon WM180T Finish: Dark Bronze MAX EPA: 0.5 USE: The 180° wall mount bracket with 2-3/8" tenon attaches flood and area fixtures to almost any surface: wall, roof, or wood pole. Provides wiring access and a built-in 2-3/8" O.D. tenon to mount a fixture with our adjustable slip-fitter. Suggested 3/8" diameter bolts for mounting. Mounting holes are spaced 3-1/4" apart.</p>		<p>2-3/8" OD Horizontal Tenon Arc Adaptor ARCA Finish: Dark Bronze MAX EPA: 0.3 USE: For use with Round, non-tapered steel and aluminum poles. 2-3/8" OD Horizontal Tenon Mid-Pole Bracket is designed to mount light fixture that is equipped with an adjustable slip-fitter onto a 2-3/8" OD horizontal tenon.</p>
	<p>5" Round Pole Mount with 3" O.D. Tenon SRPMT Finish: Dark Bronze MAX EPA: 0.3 USE: For use with Round, non-tapered steel and aluminum poles. Furnished with two 3/8" hex head stainless-steel bolts. Vertical tenon measures 3" O.D., and is made of steel tubing. Insert round pole adaptor 5inch to 3inch tenon.</p>		

ROUND EXTERNAL MOUNT HORIZONTAL TENON · To mount 2/3/4 fixtures on an existing pole

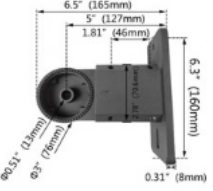
	<p>Double 90° Horizontal Tenon Adaptor D90TA Finish: Dark Bronze MAX EPA: 0.6 USE: The Bracket is designed to mount over 2-3/8" (60mm) O.D. vertical tenon. Two fixtures can be mounted to the Round External Mount Horizontal Tenon and adjusted horizontally.</p>		<p>Triple 120° Horizontal Tenon Adaptor T120TA Finish: Dark Bronze MAX EPA: 0.7 USE: The Bracket is designed to mount over 2-3/8" (60mm) O.D. vertical tenon. Three fixtures can be mounted to the Round External Mount Horizontal Tenon and adjusted horizontally.</p>
	<p>Double 180° Horizontal Tenon Adaptor D180TA Finish: Dark Bronze MAX EPA: 0.4 USE: The Bracket is designed to mount over 2-3/8" (60mm) O.D. vertical tenon. Two fixtures can be mounted to the Round External Mount Horizontal Tenon and adjusted horizontally.</p>		<p>Quad 90° Horizontal Tenon Adaptor SQ90TA Finish: Dark Bronze MAX EPA: 1.0 USE: The Bracket is designed to mount over 2-3/8" (60mm) O.D. vertical tenon. Four fixtures can be mounted to the Round External Mount Horizontal Tenon and adjusted horizontally.</p>
	<p>Single Spoke Bracket Tenon Adaptor SSBTA Finish: Dark Bronze MAX EPA: 0.4 USE: The Bracket is designed to mount over 2-3/8" (60mm) O.D. vertical tenon. One fixture can be mounted to the Round External Mount Horizontal Tenon and adjusted horizontally.</p>		<p>180° Double Bullhorn R180DB Finish: Dark Bronze MAX EPA: 0.9 USE: The Bracket is designed to mount over 2-3/8" (60mm) O.D. vertical tenon. Two fixtures can be mounted to the Round External Mount Horizontal Tenon and adjusted horizontally.</p>
	<p>180° Triple Bullhorn R180TB Finish: Dark Bronze MAX EPA: 1.4 USE: The Bracket is designed to mount over 2-3/8" (60mm) O.D. vertical tenon. Three fixtures can be mounted to the Round External Mount Horizontal Tenon and adjusted horizontally.</p>		<p>90° Quad Bullhorn R90QB Finish: Dark Bronze MAX EPA: 1.5 USE: The Bracket is designed to mount over 2-3/8" (60mm) O.D. vertical tenon. Four fixtures can be mounted to the Round External Mount Horizontal Tenon and adjusted horizontally.</p>
	<p>90° Wall Mount Bracket with 2-3/8" O.D. Tenon RWM90T Finish: Dark Bronze MAX EPA: 0.7 USE: The 90° wall mount bracket with 2-3/8" tenon attaches flood and area fixtures to almost any surface: wall, roof, or wood pole. Provides wiring access and abuilt-in 2-3/8" O.D. tenon to mount a fixture with our adjustable slip-fitter. Suggested 3/8" diameter bolts for mounting. Mounting holes are spaced 3-1/4" apart.</p>		<p>Double 180° Horizontal Tenon Adaptor RD180TA Finish: Dark Bronze MAX EPA: 1.0 USE: The Bracket is designed to mount over 2-3/8" (60mm) O.D. vertical tenon. Two fixtures can be mounted to the Round External Mount Horizontal Tenon and adjusted horizontally.</p>
	<p>Triple 120° Horizontal Tenon Adaptor RT120TA Finish: Dark Bronze MAX EPA: 1.5 USE: The Bracket is designed to mount over 2-3/8" (60mm) O.D. vertical tenon. Three fixtures can be mounted to the Round External Mount Horizontal Tenon and adjusted horizontally.</p>		<p>Double 180° Wall Mount Bracket with 2-3/8" O.D. Tenon RWMD180B Finish: Dark Bronze MAX EPA: 1.4 USE: The 180° wall mount bracket with 2-3/8" tenon attaches flood and area fixtures to almost any surface: wall, roof, or wood pole. Provides wiring access and abuilt-in 2-3/8" O.D. tenon to mount a fixture with our adjustable slip-fitter. Suggested 3/8" diameter bolts for mounting. Mounting holes are spaced 3-1/4" apart.</p>

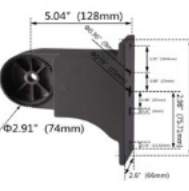
POLE BRACKET • For mounting one fixture on an existing pole

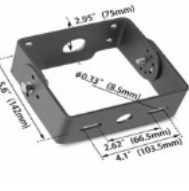
	<p>4" Square Pole Mount with 2-3/8" O.D. Tenon 4SPMT Finish: Dark Bronze MAX EPA: 0.3 USE: For use with square, non-tapered steel and aluminum poles. Furnished with four 5/16" hex head stainless-steel bolts. Vertical tenon measures 2-3/8" O.D., and is made of steel tubing. Fixtures mounted to this bracket can be adjusted both vertically and horizontally.</p>		<p>3" Round Pole Mount with 2-3/8" O.D. Tenon 3RPMT Finish: Dark Bronze MAX EPA: 0.3 USE: For use with Round, non-tapered steel and aluminum poles. Furnished with four 3/8" hex head stainless-steel bolts. Vertical tenon measures 2-3/8" O.D., and is made of steel tubing. Fixtures mounted to this bracket can be adjusted both vertically and horizontally.</p>
	<p>5" Square Pole Mount with 2-3/8" O.D. Tenon 5SPMT Finish: Dark Bronze MAX EPA: 0.3 USE: For use with square, non-tapered steel and aluminum poles. Furnished with four 5/16" hex head stainless-steel bolts. Vertical tenon measures 2-3/8" O.D., and is made of steel tubing. Fixtures mounted to this bracket can be adjusted both vertically and horizontally.</p>		<p>4" Round Pole Mount with 2-3/8" O.D. Tenon 4RPMT Finish: Dark Bronze MAX EPA: 0.3 USE: For use with Round, non-tapered steel and aluminum poles. Furnished with four 3/8" hex head stainless-steel bolts. Vertical tenon measures 2-3/8" O.D., and is made of steel tubing. Fixtures mounted to this bracket can be adjusted both vertically and horizontally.</p>
	<p>5" Round Pole Mount with 2-3/8" O.D. Tenon 5RPMT Finish: Dark Bronze MAX EPA: 0.3 USE: For use with Round, non-tapered steel and aluminum poles. Furnished with four 3/8" hex head stainless-steel bolts. Vertical tenon measures 2-3/8" O.D., and is made of steel tubing. Fixtures mounted to this bracket can be adjusted both vertically and horizontally.</p>		<p>Cast Aluminum Mast Arm Adapter AARMT Finish: Dark Bronze AARMT Mount An optional cast aluminum mast arm adapter secures fixture head to nominal 2"(2-3/8" O.D. pipe size) horizontal steel tenon arm.</p>

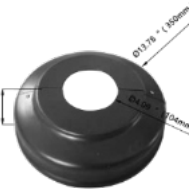
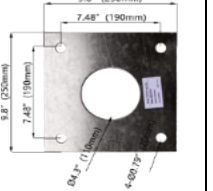
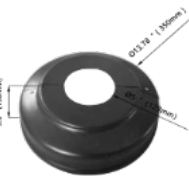
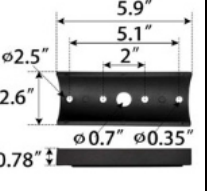
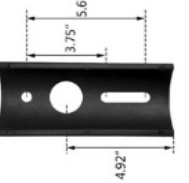
	<p>Arm Mount 4" and 5" Square and Round poles. VARMM-4/5 Finish: Dark Bronze Standard versatile mounting arm is simple to install and can be used with existing poles for retro installations.</p>		<p>Slipfitter Mount SFM Finish: Dark Bronze Slipfitter Mount An optional cast aluminum mast arm adapter secures fixture head to nominal 2"(2-3/8" O.D. pipe size) horizontal steel tenon arm.</p>
	<p>Direct Wall Mounting With 1/2" Conduit Wiring. DWM Finish: Dark Bronze Easy to install for direct wall mounting with 1/2" conduit wiring.</p>		<p>Base Mounting Screw BMS Before installing the lamp pole, the installation hook should be buried underground and fixed by cement. After fixing, the lamp pole should be fixed by locking screw and base installed.</p>
	<p>Install Base Shield IBR4 Finish: Dark Bronze The 4" Installation of base shield is used to protect the base after fixing the lamp pole, so that the lamp pole base is not damaged, thereby increasing the service life of the lamp pole.</p>		<p>Screw Positioning Plate SPP This is a screw rod positioning plate. After the screw rod of the lamp rod base is fixed underground, the positioning plate is fixed with the screw rod to prevent the screw rod from deviation. Finally, the lamp rod is locked.</p>
	<p>Install Base Shield IBR5 Finish: Dark Bronze The 5" Installation of base shield is used to protect the base after fixing the lamp pole, so that the lamp pole base is not damaged, thereby increasing the service life of the lamp pole.</p>		<p>Arm Square tube turn tube Tenon Adapter ASTTTA - 1 Finish: Dark Bronze USE: square tube light bar installation, with Arm installation of lamps.</p>
	<p>Arm Square tube turn tube Tenon Adapter ASTTTA - 2 Finish: Dark Bronze USE: square tube light bar installation, with Arm installation of lamps.</p>		