

Dimension Data:

Catalog #	Mt. height	Wall thickness	Shaft size	Bolt size	Pole weight	EPA 80	EPA 90	EPA 100	EPA 110	EPA 120
SSP-1-A-S-M-C	10 ft.	0.125 in.	4x4 in.	M0.79"X19.69"X3.94"	41 lbs.	13.5	11.3	8.9	7.3	6.8
SSP-2-A-S-M-C	15 ft.	0.125 in.	4x4 in.		55 lbs.	7.3	5.1	4.4	3.8	2.9
SSP-3-A-S-M-C	20 ft.	0.125 in.	4x4 in.		88 lbs.	3.2	2.6	1.5	0.9	0.3
SSP-4-A-L-M-C	25 ft.	0.255 in.	4x4 in.		132 lbs.	8.3	6.2	5.2	4.2	3.6
SSP-5-B-L-M-C	30 ft.	0.255 in.	5x5 in.	M0.79"X36"X4"	198 lbs.	10.1	7.0	5.7	3.7	2.4

Specification Type	10FT	15FT	20FT	25FT	30FT
SSP-1-A-S-M-C	Length=3.0 (m)	Length=4.6 (m)	Length= 6.1 (m)	Length=7.6 (m)	Length=9.1 (m)
SSP-2-A-S-M-C					
SSP-3-A-S-M-C					
SSP-4-A-L-M-C					
SSP-5-B-L-M-C					



Light pole top:

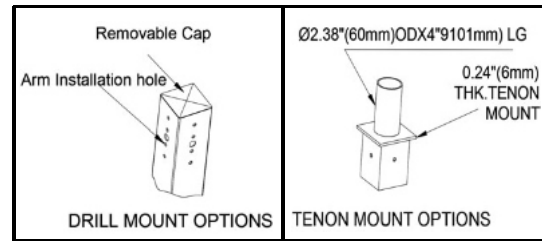

Installation:

1. Dig a hole in the installation position of the lamp pole. Fixed four fastener fittings according to the hole position of lamp pole and poured with cement concrete. (as shown in the figure)

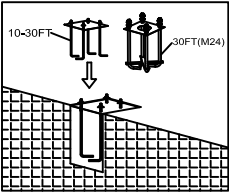

10-30FT

30FT(M24)

2. Install 4 screws onto the stick and adjust to same water level, then place the square plate and screw tightly. Install the cover at the bottom of pole. (as shown in the figure)

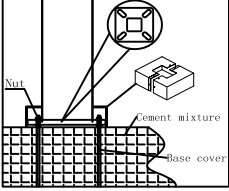

Nut

Cement mixture

Base cover

3"X5" HAND HOLE COVER

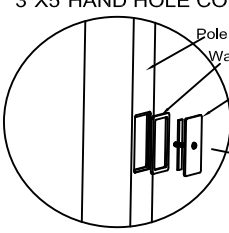

Pole

Waterproof gasket

Hand hole cover

ANCHORAGE GUIDE

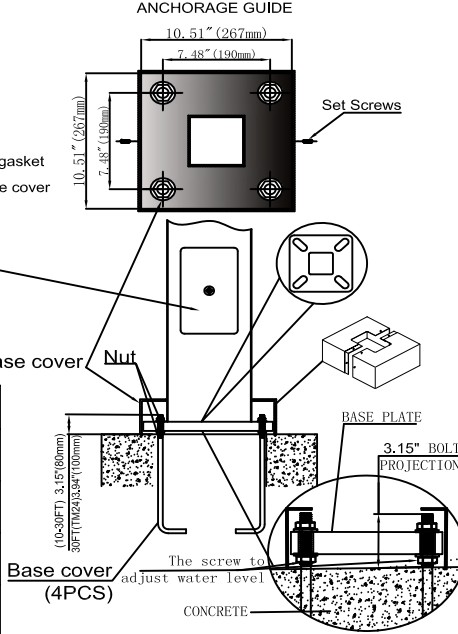

10.51" (267mm)

7.48" (190mm)

10.51" (267mm)

7.48" (190mm)

Set Screws

Flange base cover

Nut

BASE PLATE

3.15" BOLT PROJECTION

Base cover (4PCS)

CONCRETE

The screw to adjust water level

Foundation reference specification

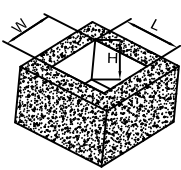

W

L

H

Reference design of Concrete size				
Specifications	L	W	H	
10-15FT	31.5"(800mm)	31.5"(800mm)	59.1"(1500mm)	
20-25FT	35.4"(900mm)	35.4"(900mm)	70.9"(1800mm)	
30FT	35.4"(900mm)	35.4"(900mm)	82.7"(2100mm)	

Foundation Design: We offer Foundation design references due to variations in soil structure across different areas, and we do not assume any responsibility for this variability.

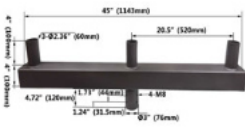
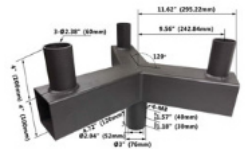
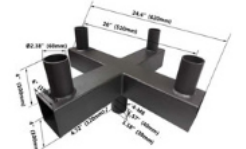
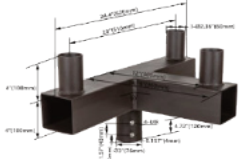
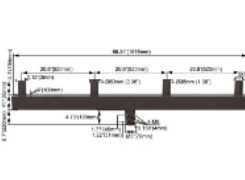
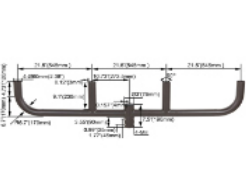

SQUARE EXTERNAL MOUNT HORIZONTAL TENON · To mount 2/3/4 fixtures on an existing pole

	<p>Low Profile Bullhorn with 3 Tenons LPB3 MAX EPA: 1.6 Finish: Dark Bronze USE: The Bracket is designed to mount over 2-3/8" O.D. vertical tenon. Two fixtures can be mounted to the Round External Mount Horizontal Tenon and adjusted horizontally.</p>		<p>Low Profile Bullhorn with 2 Tenons LPB2 MAX EPA: 1.0 Finish: Dark Bronze USE: The Bracket is designed to mount over 2-3/8" O.D. vertical tenon. Two fixtures can be mounted to the Round External Mount Horizontal Tenon and adjusted horizontally.</p>
	<p>Triple 120° Horizontal Tenon Adaptor T120TA MAX EPA: 1.4 Finish: Dark Bronze USE: The Bracket is designed to mount over 2-3/8" O.D. vertical tenon. Two fixtures can be mounted to the Round External Mount Horizontal Tenon and adjusted horizontally.</p>		<p>Quad 90° Horizontal Tenon Adaptor RQ90TA MAX EPA: 1.8 Finish: Dark Bronze USE: The Bracket is designed to mount over 2-3/8" O.D. vertical tenon. Two fixtures can be mounted to the Round External Mount Horizontal Tenon and adjusted horizontally.</p>
	<p>Square Triple 90° Horizontal Tenon Adaptor ST90TA MAX EPA: 1.5 Finish: Dark Bronze The Bracket is designed to mount over 2-3/8" O.D. vertical tenon.</p>		<p>Round Triple 90° Horizontal Tenon Adaptor RT90TA MAX EPA: 0.3 Finish: Dark Bronze The Bracket is designed to mount over 2-3/8" (60mm) O.D. vertical tenon. Triple fixtures can be mounted to the Round External Mount Horizontal Tenon and adjusted horizontally.</p>
	<p>Low Profile Bullhorn with 4 Tenons LPB4 MAX EPA: 1.7 Finish: Dark Bronze The Bracket is designed to mount over 2-3/8" O.D. vertical tenon.</p>		<p>Four 180° Horizontal Tenon Adaptor F180TA MAX EPA: 1.4 Finish: Dark Bronze The Bracket is designed to mount over 2-3/8" (60mm) O.D. vertical tenon. Four fixtures can be mounted to the Round External Mount Horizontal Tenon and adjusted horizontally.</p>





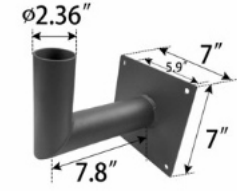
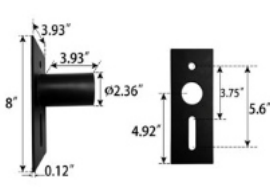
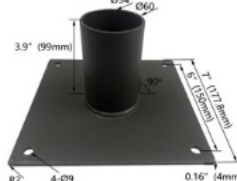
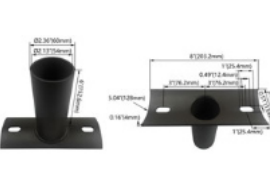

WALL BRACKET

- Attaches to any flat surface
- Provides wiring access

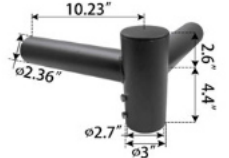
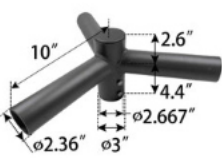
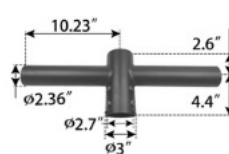
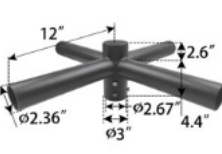

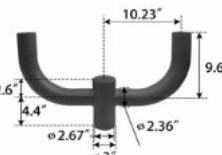
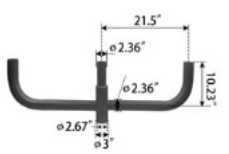
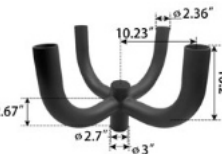
MID-POLE TENON BRACKET

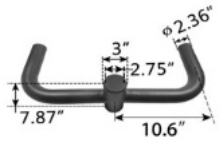
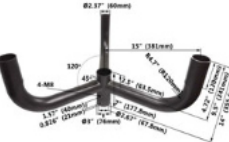
	<p>90° Wall Mount Bracket with 2-3/8" O.D. Tenon WM90T Finish: Dark Bronze MAX EPA: 0.6 USE: The 90° wall mount bracket with 2-3/8" tenon attaches flood and area fixtures to almost any surface: wall, roof, or wood pole. Provides wiring access and a built-in 2-3/8" O.D. tenon to mount a fixture with our adjustable slip-fitter. Suggested 3/8" diameter bolts for mounting. Mounting holes are spaced 3-1/4" apart.</p>		<p>2-3/8" OD Horizontal Tenon Mid-Pole Bracket MPBT Finish: Dark Bronze MAX EPA: 0.3 USE: 2-3/8" OD Horizontal Tenon Mid-Pole Bracket is designed to mount light fixture that is equipped with an adjustable slip-fitter onto a 2-3/8" OD horizontal tenon.</p>
	<p>180° Wall Mount Bracket with 2-3/8" O.D. Tenon WM180T Finish: Dark Bronze MAX EPA: 0.5 USE: The 180° wall mount bracket with 2-3/8" tenon attaches flood and area fixtures to almost any surface: wall, roof, or wood pole. Provides wiring access and a built-in 2-3/8" O.D. tenon to mount a fixture with our adjustable slip-fitter. Suggested 3/8" diameter bolts for mounting. Mounting holes are spaced 3-1/4" apart.</p>		<p>2-3/8" OD Horizontal Tenon Arc Adaptor ARCA Finish: Dark Bronze MAX EPA: 0.3 USE: For use with Round, non-tapered steel and aluminum poles. 2-3/8" OD Horizontal Tenon Mid-Pole Bracket is designed to mount light fixture that is equipped with an adjustable slip-fitter onto a 2-3/8" OD horizontal tenon.</p>
	<p>5" Round Pole Mount with 3" O.D. Tenon SRPMT Finish: Dark Bronze MAX EPA: 0.3 USE: For use with Round, non-tapered steel and aluminum poles. Furnished with two 3/8" hex head stainless-steel bolts. Vertical tenon measures 3" O.D., and is made of steel tubing. Insert round pole adaptor 5inch to 3inch tenon.</p>		

ROUND EXTERNAL MOUNT HORIZONTAL TENON · To mount 2/3/4 fixtures on an existing pole

	<p>Double 90° Horizontal Tenon Adaptor D90TA Finish: Dark Bronze MAX EPA: 0.6 USE: The Bracket is designed to mount over 2-3/8" (60mm) O.D. vertical tenon. Two fixtures can be mounted to the Round External Mount Horizontal Tenon and adjusted horizontally.</p>		<p>Triple 120° Horizontal Tenon Adaptor T120TA Finish: Dark Bronze MAX EPA: 0.7 USE: The Bracket is designed to mount over 2-3/8" (60mm) O.D. vertical tenon. Three fixtures can be mounted to the Round External Mount Horizontal Tenon and adjusted horizontally.</p>
	<p>Double 180° Horizontal Tenon Adaptor D180TA Finish: Dark Bronze MAX EPA: 0.4 USE: The Bracket is designed to mount over 2-3/8" (60mm) O.D. vertical tenon. Two fixtures can be mounted to the Round External Mount Horizontal Tenon and adjusted horizontally.</p>		<p>Quad 90° Horizontal Tenon Adaptor SQ90TA Finish: Dark Bronze MAX EPA: 1.0 USE: The Bracket is designed to mount over 2-3/8" (60mm) O.D. vertical tenon. Four fixtures can be mounted to the Round External Mount Horizontal Tenon and adjusted horizontally.</p>
	<p>Single Spoke Bracket Tenon Adaptor SSBTA Finish: Dark Bronze MAX EPA: 0.4 USE: The Bracket is designed to mount over 2-3/8" (60mm) O.D. vertical tenon. One fixture can be mounted to the Round External Mount Horizontal Tenon and adjusted horizontally.</p>		<p>180° Double Bullhorn R180DB Finish: Dark Bronze MAX EPA: 0.9 USE: The Bracket is designed to mount over 2-3/8" (60mm) O.D. vertical tenon. Two fixtures can be mounted to the Round External Mount Horizontal Tenon and adjusted horizontally.</p>
	<p>180° Triple Bullhorn R180TB Finish: Dark Bronze MAX EPA: 1.4 USE: The Bracket is designed to mount over 2-3/8" (60mm) O.D. vertical tenon. Three fixtures can be mounted to the Round External Mount Horizontal Tenon and adjusted horizontally.</p>		<p>90° Quad Bullhorn R90QB Finish: Dark Bronze MAX EPA: 1.5 USE: The Bracket is designed to mount over 2-3/8" (60mm) O.D. vertical tenon. Four fixtures can be mounted to the Round External Mount Horizontal Tenon and adjusted horizontally.</p>
	<p>90° Wall Mount Bracket with 2-3/8" O.D. Tenon RWM90T Finish: Dark Bronze MAX EPA: 0.7 USE: The 90° wall mount bracket with 2-3/8" tenon attaches flood and area fixtures to almost any surface: wall, roof, or wood pole. Provides wiring access and abuilt-in 2-3/8" O.D. tenon to mount a fixture with our adjustable slip-fitter. Suggested 3/8" diameter bolts for mounting. Mounting holes are spaced 3-1/4" apart.</p>		<p>Double 180° Horizontal Tenon Adaptor RD180TA Finish: Dark Bronze MAX EPA: 1.0 USE: The Bracket is designed to mount over 2-3/8" (60mm) O.D. vertical tenon. Two fixtures can be mounted to the Round External Mount Horizontal Tenon and adjusted horizontally.</p>
	<p>Triple 120° Horizontal Tenon Adaptor RT120TA Finish: Dark Bronze MAX EPA: 1.5 USE: The Bracket is designed to mount over 2-3/8" (60mm) O.D. vertical tenon. Three fixtures can be mounted to the Round External Mount Horizontal Tenon and adjusted horizontally.</p>		<p>Double 180° Wall Mount Bracket with 2-3/8" O.D. Tenon RWMD180B Finish: Dark Bronze MAX EPA: 1.4 USE: The 180° wall mount bracket with 2-3/8" tenon attaches flood and area fixtures to almost any surface: wall, roof, or wood pole. Provides wiring access and abuilt-in 2-3/8" O.D. tenon to mount a fixture with our adjustable slip-fitter. Suggested 3/8" diameter bolts for mounting. Mounting holes are spaced 3-1/4" apart.</p>

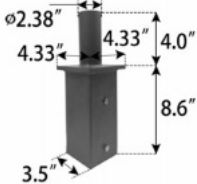
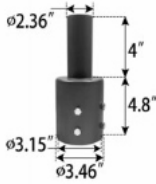
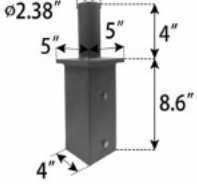
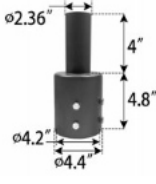
POLE BRACKET • For mounting one fixture on an existing pole

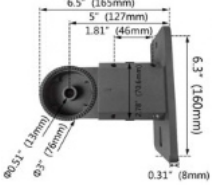
	<p>4" Square Pole Mount with 2-3/8" O.D. Tenon 4SPMT Finish: Dark Bronze MAX EPA: 0.3 USE: For use with square, non-tapered steel and aluminum poles. Furnished with four 5/16" hex head stainless-steel bolts. Vertical tenon measures 2-3/8" O.D., and is made of steel tubing. Fixtures mounted to this bracket can be adjusted both vertically and horizontally.</p>		<p>3" Round Pole Mount with 2-3/8" O.D. Tenon 3RPMT Finish: Dark Bronze MAX EPA: 0.3 USE: For use with Round, non-tapered steel and aluminum poles. Furnished with four 3/8" hex head stainless-steel bolts. Vertical tenon measures 2-3/8" O.D., and is made of steel tubing. Fixtures mounted to this bracket can be adjusted both vertically and horizontally.</p>
	<p>5" Square Pole Mount with 2-3/8" O.D. Tenon 5SPMT Finish: Dark Bronze MAX EPA: 0.3 USE: For use with square, non-tapered steel and aluminum poles. Furnished with four 5/16" hex head stainless-steel bolts. Vertical tenon measures 2-3/8" O.D., and is made of steel tubing. Fixtures mounted to this bracket can be adjusted both vertically and horizontally.</p>		<p>4" Round Pole Mount with 2-3/8" O.D. Tenon 4RPMT Finish: Dark Bronze MAX EPA: 0.3 USE: For use with Round, non-tapered steel and aluminum poles. Furnished with four 3/8" hex head stainless-steel bolts. Vertical tenon measures 2-3/8" O.D., and is made of steel tubing. Fixtures mounted to this bracket can be adjusted both vertically and horizontally.</p>
	<p>5" Round Pole Mount with 2-3/8" O.D. Tenon 5RPMT Finish: Dark Bronze MAX EPA: 0.3 USE: For use with Round, non-tapered steel and aluminum poles. Furnished with four 3/8" hex head stainless-steel bolts. Vertical tenon measures 2-3/8" O.D., and is made of steel tubing. Fixtures mounted to this bracket can be adjusted both vertically and horizontally.</p>		<p>Cast Aluminum Mast Arm Adapter AARMT Finish: Dark Bronze AARMT Mount An optional cast aluminum mast arm adapter secures fixture head to nominal 2"(2-3/8" O.D. pipe size) horizontal steel tenon arm.</p>

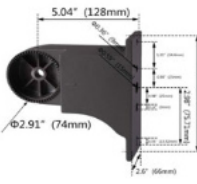
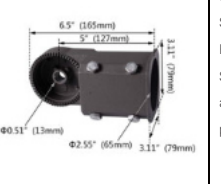
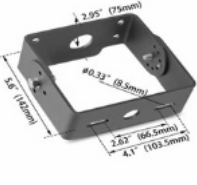
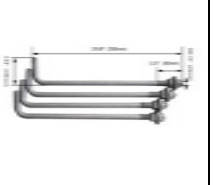
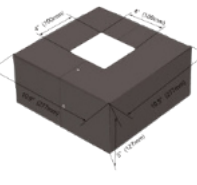
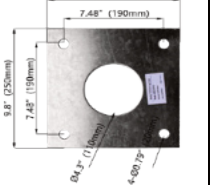
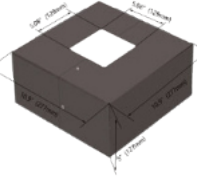
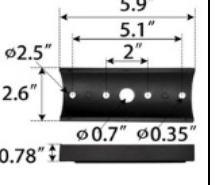
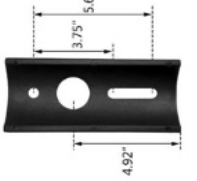
	<p>Arm Mount 4" and 5" Square and Round poles. VARMM-4/5 Finish: Dark Bronze Standard versatile mounting arm is simple to install and can be used with existing poles for retro installations.</p>		<p>Slipfitter Mount SFM Finish: Dark Bronze Slipfitter Mount An optional cast aluminum mast arm adapter secures fixture head to nominal 2"(2-3/8" O.D. pipe size) horizontal steel tenon arm.</p>
	<p>Direct Wall Mounting With 1/2" Conduit Wiring. DWM Finish: Dark Bronze Easy to install for direct wall mounting with 1/2" conduit wiring.</p>		<p>Base Mounting Screw BMS Before installing the lamp pole, the installation hook should be buried underground and fixed by cement. After fixing, the lamp pole should be fixed by locking screw and base installed.</p>
	<p>Install Base Shield 4in IBS4 Finish: Dark Bronze The 4" Installation of base shield is used to protect the base after fixing the lamp pole, so that the lamp pole base is not damaged, thereby increasing the service life of the lamp pole.</p>		<p>Screw Positioning Plate SPP This is a screw rod positioning plate. After the screw rod of the lamp rod base is fixed underground, the positioning plate is fixed with the screw rod to prevent the screw rod from deviation. Finally, the lamp rod is locked.</p>
	<p>Install Base Shield 5in IBS5 Finish: Dark Bronze The 5" Installation of base shield is used to protect the base after fixing the lamp pole, so that the lamp pole base is not damaged, thereby increasing the service life of the lamp pole.</p>		<p>Arm Square tube turn tube Tenon Adapter ASTTTA - 1 Finish: Dark Bronze USE: square tube light bar installation, with Arm installation of lamps.</p>
	<p>Arm Square tube turn tube Tenon Adapter ASTTTA - 2 Finish: Dark Bronze USE: square tube light bar installation, with Arm installation of lamps.</p>		